

AW-CU300A V3

IEEE 802.11 b/g/n WLAN Microcontroller Module

Datasheet

Rev. B

B1H

For Standard

Features

WLAN

- ◆ Support 802.11 b/g/n
- ◆ Single stream 802.11n with 20 MHz
Up to MCS7 data rates (72.2 Mbps)
- ◆ Antenna Diversity:
Support printed Antenna for Internal Antenna
Support U.FL Connector for External Antenna
- ◆ Multiple IO supported
UART/JTAG/I2C/GPIO/SSP/GPT
- ◆ 4M Byte QSPI flash integrated.
- ◆ 74 pin LGA Module – 28 mm x 15 mm x 2.35 mm

Certifications

- FCC/CE/IC/NCC
 - FCC ID: TLZ-CU300
 - IC ID: 6100A-CU300
 - NCC ID: CCAI18LP2090T5

Revision History

Document NO: R2-2496-DST-02

Version	Revision Date	DCN NO.	Description	Initials	Approved
A	2020/05/20	DCN017613	<ul style="list-style-type: none"> Draft version 	Renton Tao	N.C Chen
B	2021/06/30	DCN022560	<ul style="list-style-type: none"> Update to MP version Update to new format 	Renton Tao	N.C Chen

Table of Contents

Revision History	3
Table of Contents	4
1. Introduction.....	5
1.1 Product Overview	5
1.2 Block Diagram.....	6
1.3 Specifications Table	7
1.3.1 General	7
1.3.2 WLAN.....	7
1.3.3 Operating Conditions.....	8
2. Pin Definition	10
2.1 Pin Map.....	10
2.2 Pin Table.....	11
2.2.1 Power	11
2.2.2 GPIO.....	11
2.2.3. GND.....	12
2.2.4. NC	13
3. Electrical Characteristics	14
3.1 Absolute Maximum Ratings	14
3.2 Recommended Operating Conditions	14
3.3 Digital IO Pin DC Characteristics.....	14
3.3.1 3.3V Operation (M_3V3).....	14
3.4 Power Consumption	15
3.5 Internal QSPI Flash	16
3.6 External 32.768KHZ Crystal Requirement.....	16
4. Mechanical Information	17
4.1 Mechanical Drawing	17
5. Packing Information.....	19
Appendix	23

1. Introduction

1.1 Product Overview

AzureWave presents **AW-CU300A V3** Wi-Fi Microcontroller Smart Energy Platform Solution provides a highly cost-effective, flexible and easy to-use hardware/software platform to build a new generation of connected, smart devices. These smart-connected devices enable device to deliver a broad-range of services to consumers including energy-management, demand-response, home automation and remote access. This allows a user to manage comfort and convenience, also run diagnostics and receive alerts and notifications, in addition to managing and controlling the device. Developers can leverage the rich connectivity features of these new smart devices to create a new generation of innovative new applications and services

The platform builds upon the success of NXP's first-generation Wi-Fi microcontroller platform using the NXP 88MW320 Wi-Fi System-on-Chip (SoC), a 4MByte QSPI flash memory and NXP Easy Connect software.

The **AW-CU300A V3** is powered by production quality, field-tested NXP Easy Connect software that includes a rich set of software components that work together to support the development of Smart Energy devices, and enable these devices to connect to mobile clients such as smart-phones, Internet-based Cloud and Smart-Grid services. The feature-rich software stack enables OEMs to focus on application-specific software functionality, thus enabling rapid development and reduced software development costs and risks.

1.2 Block Diagram

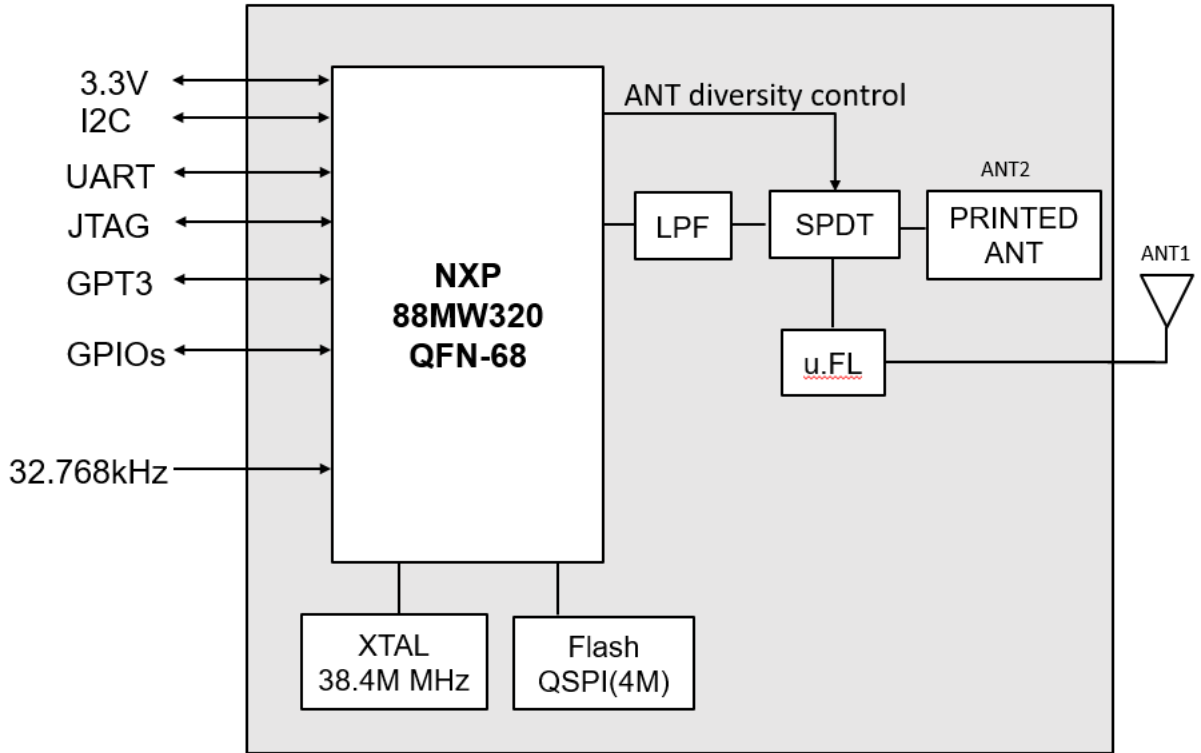

Block Diagram of AW-CU300A V3

1.3 Specifications Table

1.3.1 General

Features	Description
Product Description	IEEE 802.11b/g/n, Wi-Fi compliant
Major Chipset	NXP 88MW320 + QSPI flash
Host Interface	UART/JTAG/SSP/I2C
Dimension	28 mm x 15 mm x 2.35 mm
Package	74-pin LGA
Antenna	u.FL Connector Receptacle ANT1 : WiFi → TX/RX(diversity) Printed antenna ANT2 : WiFi → TX/RX(diversity)
Weight	1.7 g

1.3.2 WLAN

Features	Description
WLAN Standard	IEEE802.11 b/g/n
Frequency Range	2.4 GHz ISM Bands 2.412-2.472 GHz
Modulation	DSSS, OFDM, DBPSK, DQPSK, CCK, 16-QAM, 64-QAM
Number of Channels	2.4GHz: <ul style="list-style-type: none"> ■ USA, NORTH AMERICA, Canada and Taiwan - 1 ~ 11 ■ China, Australia, Most European Countries - 1 ~ 13 ■ Japan, 1 ~ 13

Output Power (Board Level Limit)*	2.4G				
		Min	Typ	Max	Unit
	11b (11Mbps) @EVM<35%	15.5	17	18.5	dBm
	11g (54Mbps) @EVM \leq -27 dB	12.5	14	15.5	dBm
	11n (HT20 MCS7) @EVM \leq -28 dB	11.5	13	14.5	dBm
<p>* FCC/CE output power limit spec: - Refer to "2.4 CERTIFICATIONS FCC/ETSI WIFI 2.4GHZ POWER TABLE"</p>					
Receiver Sensitivity	2.4G				
		Min	Typ	Max	Unit
	11b (11Mbps)	-	-84		dBm
	11g (54Mbps)	-	-69		dBm
	11n (HT20 MCS7)	-	-66		dBm
Data Rate	WLAN: 802.11b : 1, 2, 5.5, 11Mbps 802.11a/g : 6, 9, 12, 18, 24, 36, 48, 54Mbps 802.11n : Maximum data rates up to 72.2 Mbps (20 MHz channel)				
Security	WPA/WPA3				

* If you have any certification questions about output power please contact FAE directly.

1.3.3 Operating Conditions

Features	Description
Operating Conditions	
Voltage	3.3V +-5%
Operating Temperature	-30°C ~ 85°C
Operating Humidity	Less than 85% R.H.
Storage Temperature	-40°C to +85°C
Storage Humidity	Less than 60% R.H.

ESD Protection	
Human Body Model	+/-2KV
Changed Device Model	+/-500V

2. Pin Definition

2.1 Pin Map

AW-CU300A V3 pin out drawing (top view).

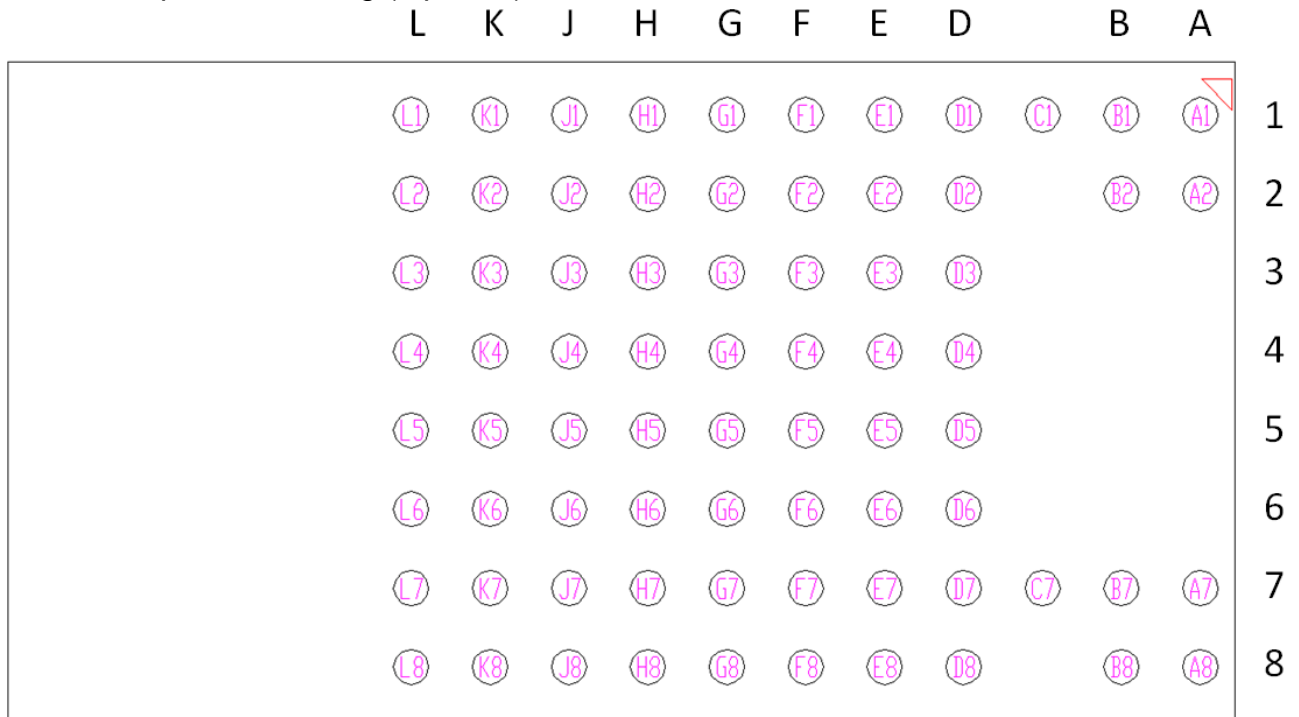

TOP VIEW

2.2 Pin Table

2.2.1 Power

Pin No	Definition	Basic Description	Type	Level
E7	B_3V3	3.3V Power input	PWR	3.3V
D7	M_3V3	3.3V Power input	PWR	3.3V

2.2.2 GPIO

Pin No	Definition	Function 0	Function 1	Function 2	Function 3	Function 4	Function 5	Type	Level
H1	GPIO_0	GPIO_0	GPT0_CH0	UART0_CTS	SSP0_CLK			I/O	3.3V
H2	GPIO_1	GPIO_1	GPT0_CH1	UART0_RTS	SSP0_FRM			I/O	3.3V
J1	GPIO_2	GPIO_2	GPT0_CH2	UART0_TXD	SSP0_TXD			I/O	3.3V
J2	GPIO_3	GPIO_3	GPT0_CH3	UART0_RXD	SSP0_RXD			I/O	3.3V
K1	GPIO_4	GPIO_4	GPT0_CH4	I2C0_SDA	AUDIO_CLK			I/O	3.3V
K2	GPIO_5	GPIO_5	GPT0_CH5	I2C0_SCL				I/O	3.3V
E2	GPIO_39	GPIO_39	GPT3_CLKIN	UART1_RXD	SSP1_RXD			I/O	3.3V
K8	GPIO_6	JTAG TDO	GPIO_6	I2C1_SDA				I/O	3.3V
H8	GPIO_7	JTAG TCK	GPIO_7	UART2_CTS	SSP2_CLK	I2C0_SDA		I/O	3.3V
H7	GPIO_8	JTAG TMS	GPIO_8	UART2_RTS	SSP2_FRM	I2C0_SDL		I/O	3.3V
J8	GPIO_9	JTAG TDI	GPIO_9	UART2_TXD	SSP2_TXD	I2C1_SDA		I/O	3.3V
J7	GPIO_10	JTAG TRST	GPIO_10	UART2_RXD	SSP2_RXD	I2C1_SDL		I/O	3.3V
E6	GPIO_16	GPIO_16	CON[5]		AUDIO_CLK			I/O	3.3V
F6	GPIO_27	GPIO_27	CON[4]	UART0_TXD				I/O	3.3V
F8	GPIO_22	WAKE_UP_0	GPIO_22					I/O	3.3V
F7	GPIO_23	WAKE_UP_1	GPIO_23	UART0_CTS			COMP_IN_P	I/O	3.3V
F3	GPIO_24		GPIO_24	UART0_RXD	GPT1_CH5		COMP_IN_N	I/O	3.3V
G8	GPIO_26	32KHzCLK_OUT	GPIO_26	I2C1_SCL				I/O	3.3V
D2	GPIO_40	GPIO_40	ADC_DAC_T RIGGER0	ACOMP0_GPIO_OUT	ACOMP1_GPIO_OUT			I/O	3.3V
D3	GPIO_41	GPIO_41	ADC_DAC_T RIGGER1	ACOMP0_EDGE_PULSE	ACOMP1_EDGE_PULSE			I/O	3.3V
E1	GPIO_42	GPIO_42	ADC_0/ ACOMP0	UART1_CTS	SSP_CLK			I/O	3.3V
E8	GPIO_43	GPIO_43	ADC_1/ ACOMP1	UART1_RTS	SSP1_FRM			I/O	3.3V
F1	GPIO_46	GPIO_46	ADC_4/ ACOMP4	UART2_CTS	SSP2_CLK			I/O	3.3V

F2	GPIO_47	GPIO_47	ADC_5/ ACOMP5	UART2_RTS	SSP2_FRM			I/O	3.3V
G1	GPIO_48	GPIO_48	ADC_6/ ACOMP6	UART2_TXD	SSP2_TXD			I/O	3.3V
G2	GPIO_49	GPIO_49	ADC_7/ ACOMP7	UART2_RXD	SSP2_RXD			I/O	3.3V
G7	GPIO_25	32KHz_CLK_I N	GPIO_25	I2C1_SDA				I/O	3.3V
K7	RESETN	RESETN	Host reset					I/O	3.3V(internal pull high 51k ohm)
E4 ⁽¹⁾	GPIO_28							I/O	3.3V
E5 ⁽¹⁾	GPIO_29							I/O	3.3V
D6 ⁽¹⁾	GPIO_30							I/O	3.3V
D4 ⁽¹⁾	GPIO_31							I/O	3.3V
E3 ⁽¹⁾	GPIO_32							I/O	3.3V
D5 ⁽¹⁾	GPIO_33							I/O	3.3V

NOTE (1): Dummy pin E4, E5, D6, D4, E3, and D5.

2.2.3. GND

Pin No	Basic Description
A1	GND
A2	
A7	
A8	
B1	
B2	
B7	
B8	
C1	
C7	
D1	
D8	
F4	
F5	
G3	
G4	
G5	
G6	
H3	

Pin No	Basic Description
H4	GND
H5	
H6	
J3	
J4	
J5	
J6	
K3	
K4	
K5	
K6	
L1	
L2	
L3	
L4	
L5	
L6	
L8	

2.2.4. NC

Pin No	Basic Description	Remark
L7	DNS(Don't connect)	

3. Electrical Characteristics

3.1 Absolute Maximum Ratings

Symbol	Parameter	Pin No	Min	Typ	Max	Units
B_3V3	3.3V power supply	E7		3.3	3.6	V
M_3V3	3.3V power supply	D7		3.3	3.6	V

3.2 Recommended Operating Conditions

Symbol	Parameter	Pin No	Min	Typ	Max	Units
B_3V3	3.3V power supply	E7	3.0	3.3	3.6	V
M_3V3	3.3V power supply	D7	3.0	3.3	3.6	V

3.3 Digital IO Pin DC Characteristics

3.3.1 3.3V Operation (M_3V3)

Symbol	Parameter	Minimum	Typical	Maximum	Unit
V _{IH}	Input high voltage	0.7* M_3V3	-	M_3V3+0.4	V
V _{IL}	Input low voltage	-0.4	-	0.3* M_3V3	
V _{OH}	Output High Voltage	M_3V3-0.4	-	-	
V _{OL}	Output Low Voltage	-	-	0.4	
V _{HYS}	Input Hysteresis	100			mV

3.4 Power Consumption

- CURRENT consumption (normal/POWER SAVING MODES)

Power Supply=3.3V				
MCU Status	WiFi Deep Sleep	WiFi STA Connected	WiFi IEEE Power Saving	WiFi Power Down
	200Mhz	200Mhz	200Mhz	200Mhz
PM0(Active)	36.7	77.2	37.8	N/A ⁽¹⁾
PM1(Idle)	27.6	67.9	28.8	N/A ⁽¹⁾
PM2(Standby)	1.25	43.0	DTIM1=2.5 DTIM10=1.4	1.2
PM3(Sleep)	0.98	42.6	DTIM1=2.3 DTIM10=1.2	0.93
PM4(Shutdown)	0.95	42.5	DTIM1=2.1 DTIM10=1.1	0.90

Current Unit: mA

(1) The MCU gets its clock from the WiFi subsection. When WiFi is powered down, the MCU is forced to run off of the internal RC32M clock. NXP does not recommend this and hence this mode is not supported. Customers can instead put the WiFi in Deep Sleep to save power.

- CURRENT consumption (MFG WLAN TX /RX)

Item				Power Supply=3.3V			
Band (GHz)	Mode	BW (MHz)	RF Power (dBm)	Transmit		Receive	
				Max.	Avg.	Max.	Avg.
2.4	11b@1M	20	17	315.3	310.8	78.3	78.2
	11b@11M	20	17	301.7	295.9	78.5	78.4
	11g@54M	20	14	243.5	241.2	80.2	80.1
	11n@MCS7	20	13	233.8	230.6	80.3	80.1

*Current Unit: mA

Note: DUT set Adjust Packet gap with Sifs. Ext: Enter option: 35 1 1

3.5 Internal QSPI Flash

A QSPI Flash is used in AW-CU300A. The size of the internal QSPI Flash is 32Mbit (4MByte).

Manufacturer	Manufacturer's part number
GigaDevice	GD25Q series

3.6 External 32.768KHZ Crystal Requirement

An external 32.768kHz crystal can be used for low-power consumption. Below are the specifications for this crystal.

Parameter	Min	Typ	Max	Unit
Crystal Frequency		32.768		kHz
Frequency accuracy tolerance	-40		40	ppm
Startup time			600	ms
Duty cycle tolerance		50		%
Crystal load capacitance		12.5		pF
Crystal shunt capacitance			7	pF
ESR (Equivalent series resistance)			100	kOhm

4. Mechanical Information

4.1 Mechanical Drawing

The size and thickness of the AW-CU300A V3 LGA package module is listed below:

- AW-CU300A V3 Drawing

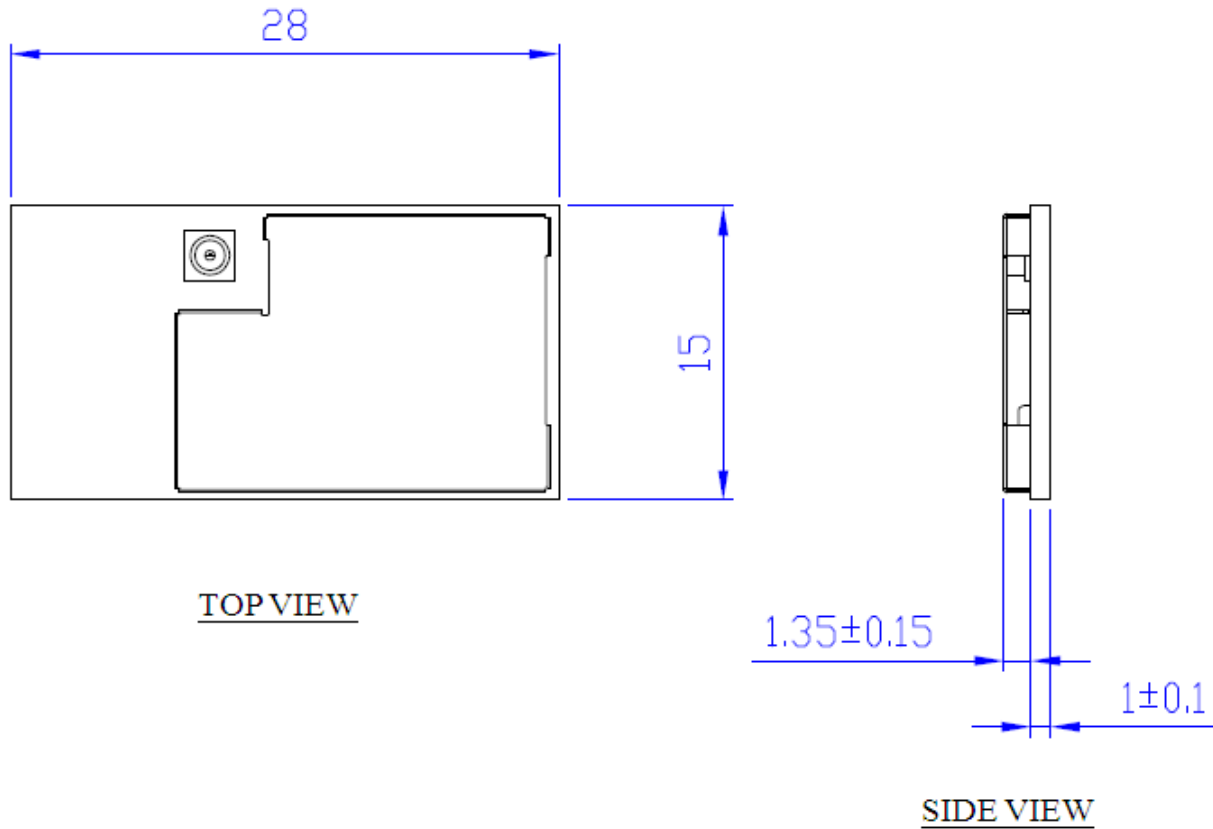

Tolerances unless otherwise specified : ± 0.15 mm

- **AW-CU300A V3 TOP View PCB Layout Footprint**

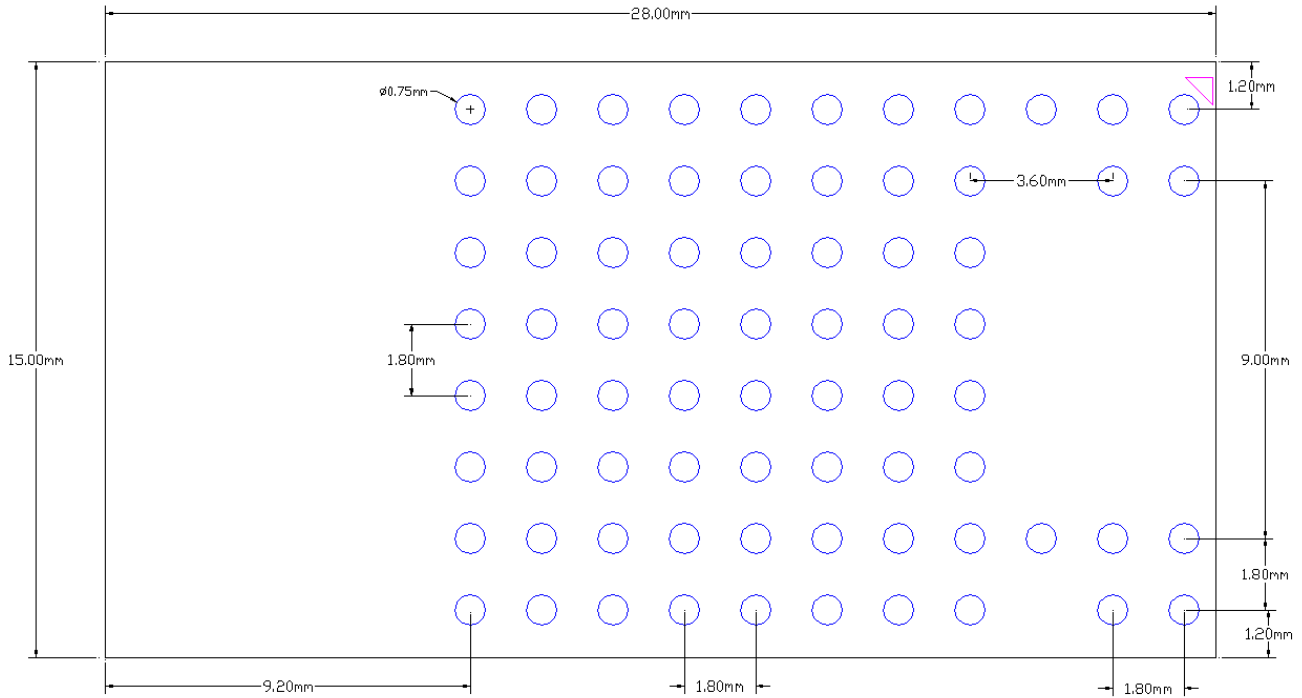

TOP VIEW

5. Packing Information

1. One reel can pack 3,000pcs modules
2. One production label is pasted on the reel, one desiccant and one humidity indicator card are put on the reel

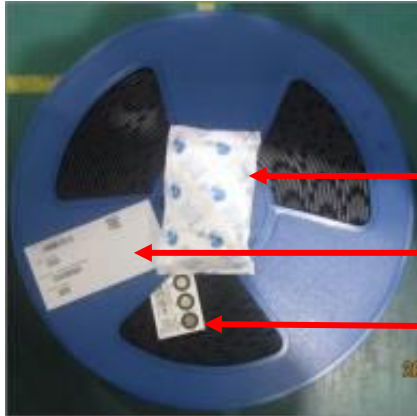

One desiccant

One production label

One humidity indicator card

3. One reel is put into the anti-static moisture barrier bag, and then one label is pasted on the bag



One production label

4. A bag is put into the anti-static pink bubble wrap

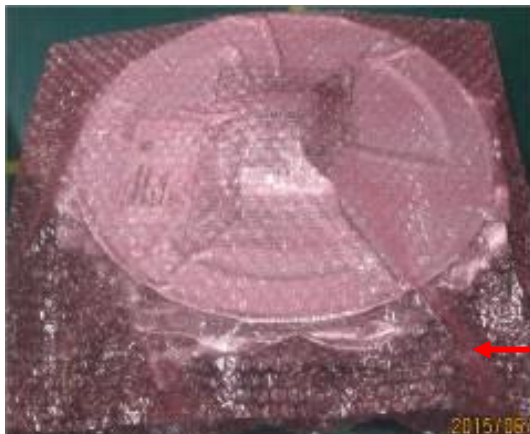

One anti-static pink bubble wrap

5. A bubble wrap is put into the inner box and then one label is pasted on the inner box



One production label

6. 5 inner boxes could be put into one carton

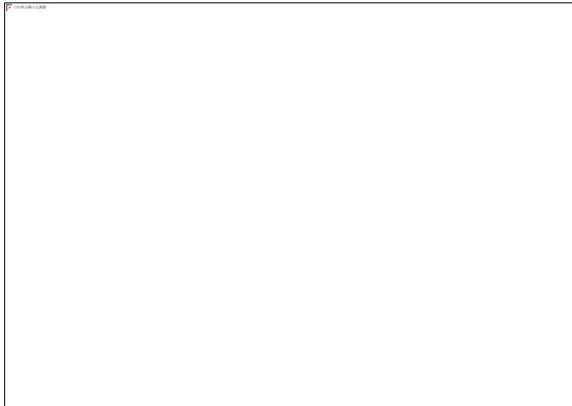



7. Sealing the carton by AzureWave tape



8. One carton label and one box label are pasted on the carton. If one carton is not full, one balance label pasted on the carton

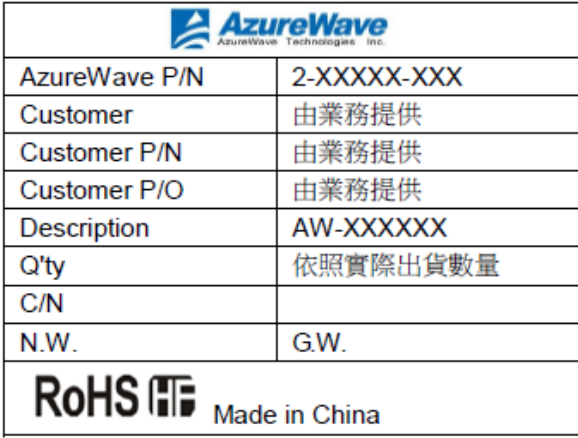

<p>Example of carton label</p>	 <table border="1"> <tr> <td colspan="2" style="text-align: center;"></td> </tr> <tr> <td>AzureWave P/N</td> <td>2-XXXXX-XXX</td> </tr> <tr> <td>Customer</td> <td>由業務提供</td> </tr> <tr> <td>Customer P/N</td> <td>由業務提供</td> </tr> <tr> <td>Customer P/O</td> <td>由業務提供</td> </tr> <tr> <td>Description</td> <td>AW-XXXXXX</td> </tr> <tr> <td>Q'ty</td> <td>依照實際出貨數量</td> </tr> <tr> <td>C/N</td> <td></td> </tr> <tr> <td>N.W.</td> <td>G.W.</td> </tr> <tr> <td colspan="2" style="text-align: center;">RoHS Made in China</td> </tr> </table>			AzureWave P/N	2-XXXXX-XXX	Customer	由業務提供	Customer P/N	由業務提供	Customer P/O	由業務提供	Description	AW-XXXXXX	Q'ty	依照實際出貨數量	C/N		N.W.	G.W.	RoHS Made in China	
AzureWave P/N	2-XXXXX-XXX																				
Customer	由業務提供																				
Customer P/N	由業務提供																				
Customer P/O	由業務提供																				
Description	AW-XXXXXX																				
Q'ty	依照實際出貨數量																				
C/N																					
N.W.	G.W.																				
RoHS Made in China																					
<p>Example of box label</p>	 <p style="text-align: center;">2-XXXXX-XXX</p> <p style="text-align: center;">数量: XXX</p> <p style="text-align: center;">XXXXXX 股份有限公司</p>																				

Example of production label	
Example of balance label	

Note:

- ◆ 1 reel = 1 inner box = 1,000pcs
- ◆ 1 carton = 3 inner boxes = 3 * 1,000pcs = 3,000pcs

Appendix

A. FCC WIFI 2.4GHz power table:

Internal ANT(5.12dBi)/PIFA ANT(4dBi)/Dipole ANT(3dBi)/Monopole ANT(3dBi)

Peak: Peak power is for certification, which follow FCC KDB 558074 D01 DTS Meas Guidance v03r01

AVG: Average power measured by the power meter

AVG: Average power measured by the power meter

Test condition: Under limit 2.5dB

Mode:		11b		Data Rate:		1Mbps		Directional Gain (dBi):			
Channel	Frequency (MHz)	Power Setting	Chain0								
			Gain:	0.00							
			Avg (dBm)	Peak (dBm)							
1	2412	15	16.01	18.37							
6	2437	17	17.64	20.01							
11	2462	16	16.56	19.10							

Mode:		11g		Data Rate:		6Mbps					
1	2412	11	12.24	21.89							
6	2437	14	14.94	23.11							
11	2462	12	12.86	22.37							

Mode:		11n20 2.4G		Data Rate:		MCS0 6.5Mbps					
1	2412	9	10.31	19.01							
6	2437	13	13.58	22.11							
11	2462	11	11.68	20.67							

(a) ETSI WIFI 2.4GHz power table:

Mode:		Tx 11b				Data Rate:	1Mbps			Gain(dBi) :	5.12		
Channel	Freq. (MHz)	Power Setting	Conducted AVG Power (dBm)				EIRP						
			Chain0			Total	Tnorm	Tmin		Tmax		Limit (dBm)	
1	2412	12	13.40				13.40	18.52	18.99		18.02		20.00
7	2442	12	13.35				13.35	18.47	18.88		17.96		20.00
13	2472	13	13.68				13.68	18.80	19.14		18.26		20.00

Mode:		Tx 11g				Data Rate:	6Mbps			Gain(dBi) :	5.12		
Channel	Freq. (MHz)	Power Setting	Conducted AVG Power (dBm)				EIRP						
			Chain0			Total	Vnorm	Vnorm		Vnorm		Limit (dBm)	
1	2412	13	14.19				14.19	19.31	19.78		18.81		20.00
7	2442	13	14.16				14.16	19.28	19.69		18.77		20.00
13	2472	13	13.97				13.97	19.09	19.43		18.55		20.00

Mode:		Tx 11n20 2.4G				Data Rate:	MCS0 6.5Mbps			Gain(dBi) :	5.12		
Channel	Freq. (MHz)	Power Setting	Conducted AVG Power (dBm)				EIRP						
			Chain0			Total	Vnorm	Vnorm		Vnorm		Limit (dBm)	
1	2412	13	14.21				14.21	19.33	19.80		18.83		20.00
7	2442	13	14.19				14.19	19.31	19.72		18.80		20.00
13	2472	13	13.95				13.95	19.07	19.41		18.53		20.00

B. ANTENNA SPEC (FCC/CE CERTIFICATIONS)

Internal antenna with certifications FCC/CE:

- PCB antenna
 - Peak Gain 5.12dBi (2.4GHz~2.5GHz)

External antennas with certifications FCC/CE:

- Monopole antenna[FXP73.07.0100A, TAOGLAS]
 - Peak Gain 3dBi (2.4GHz~2.5GHz)
- Dipole antenna[PC11.07.0100A, TAOGLAS]
 - Peak Gain 3dBi (2.4GHz~2.5GHz)
- PIFA antenna[FXP74.07.0100A, TAOGLAS]
 - Peak Gain 4dBi (2.4GHz~2.5GHz)